

🇬🇧 HOLZKNECHT 🇬🇧

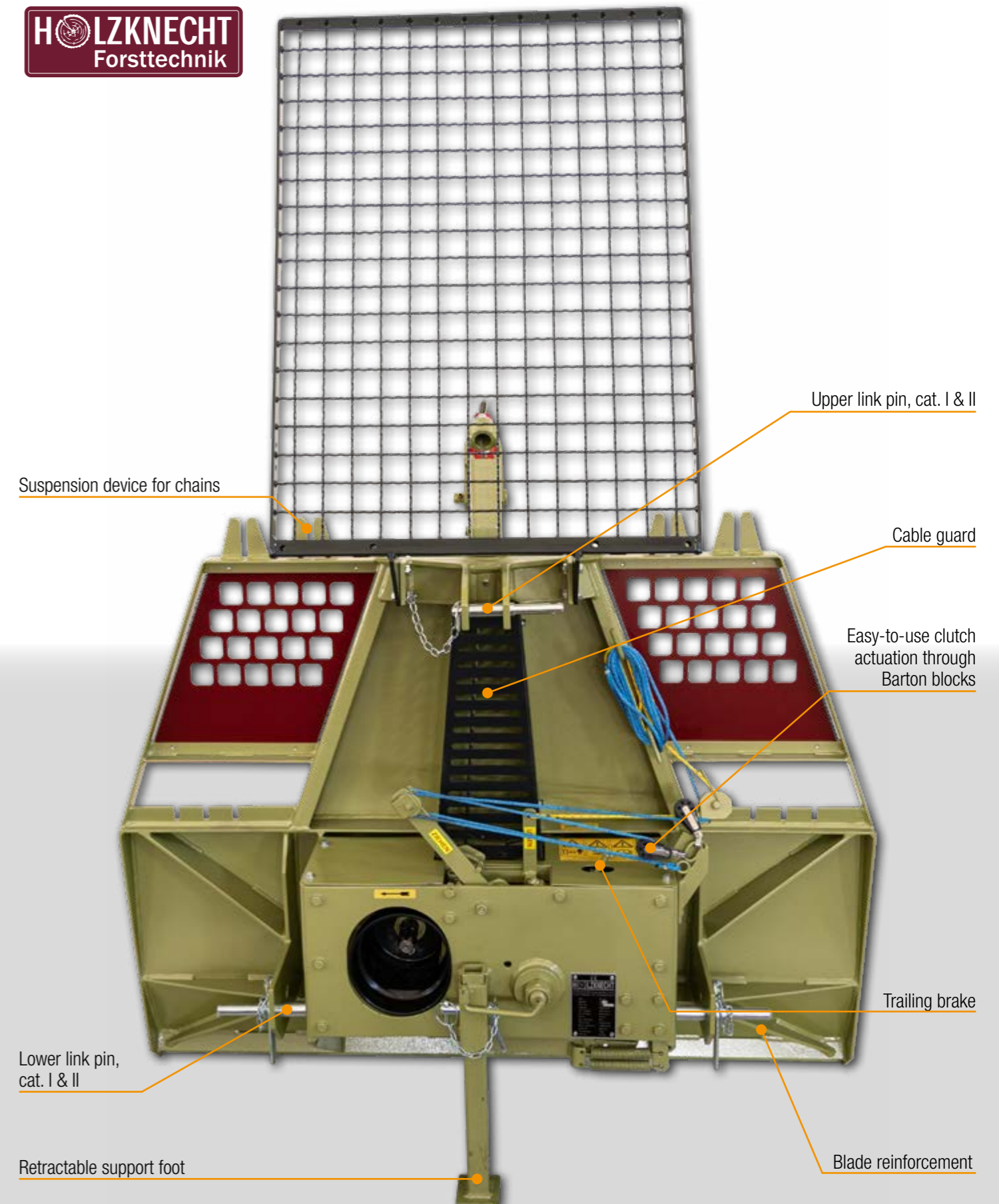

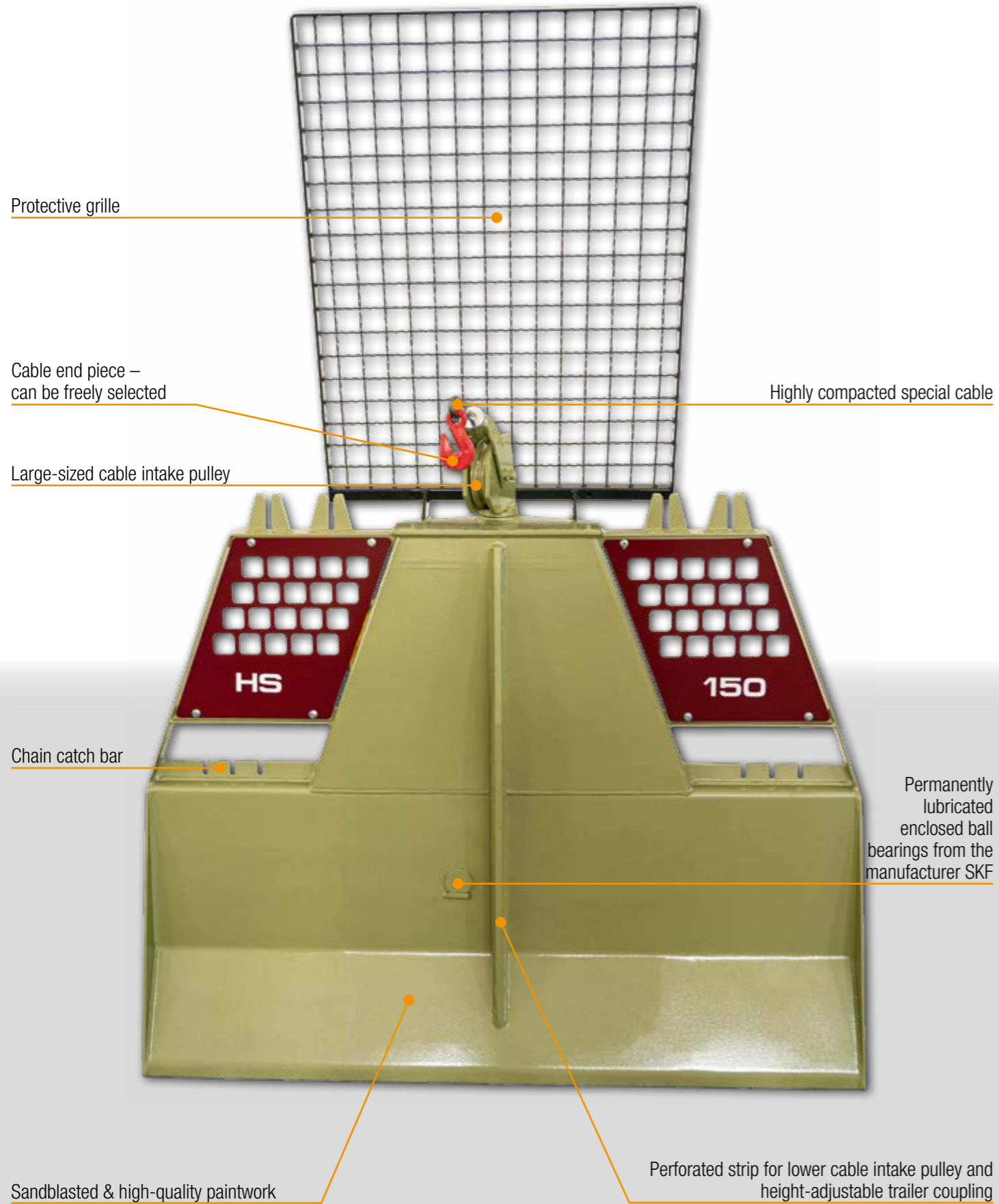

HOLZKNECHT HS 135 • HS 145 • HS 150 • HS 155



TECHNICAL SPECIFICATIONS:

	HS 135	HS 145
Tractive performance	3,5 t	4,5 t
Cable retraction speed	40m / min	40m / min
Cable attachment	60m / 10 Ø	80m / 10 Ø
	75m / 9 Ø	100m / 9 Ø
Recommended cable length	60m / 9 Ø	60m / 10 Ø
Blade width	1.000 mm	1.250 mm
Cable winch height with protective grille	2.020 mm	2.100 mm
Cable intake height	1.150 mm	1.200 mm
Weight	155 kg	170 kg
For tractors from	10 kW	10 kW

TECHNICAL SPECIFICATIONS:

	HS 150	HS 155
Tractive performance	5,0 t	5,5 t
Cable retraction speed	40m / min	40m / min
Cable attachment	80m / 10 Ø	80m / 11 Ø
	100m / 9 Ø	100m / 10 Ø
Recommended cable length	70m / 10 Ø	90m / 10 Ø
Blade width	1.500 mm	1.600 mm
Cable winch height with protective grille	2.100 mm	2.350 mm
Cable intake height	1.250 mm	1.350 mm
Weight	210 kg	280 kg
For tractors from	20 kW	25 kW

■ Robust mechanical operation

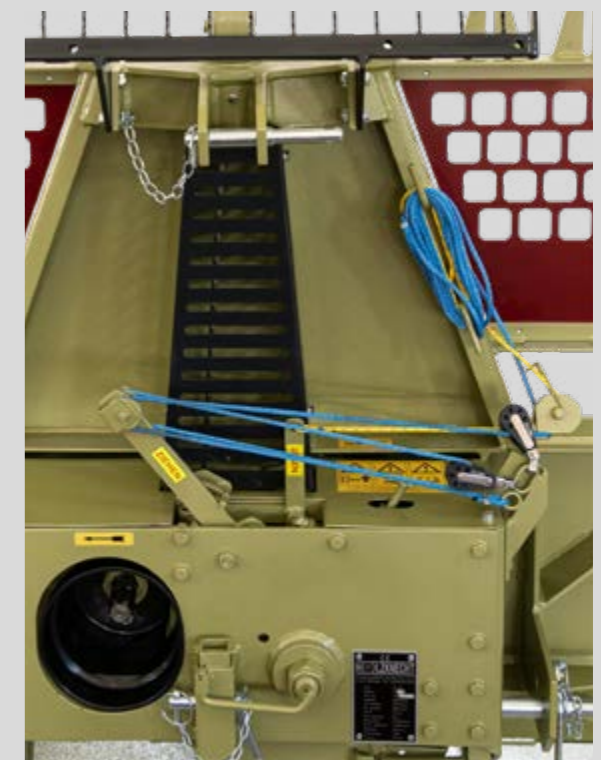

HOLZKNECHT HS 5 CLASSIC

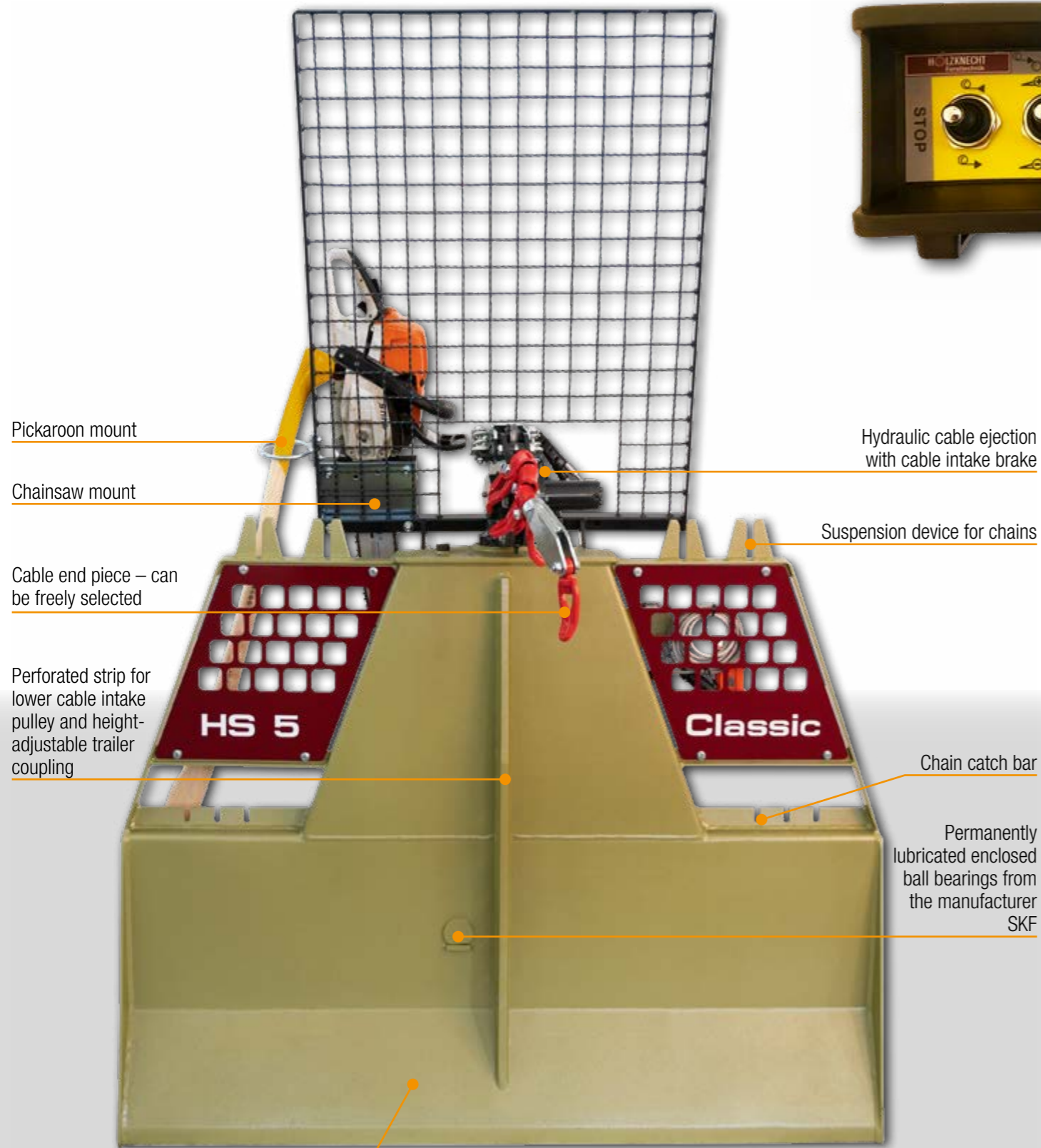

Infinitely variable adjustment of the cable ejection speed

7-pin socket for radio system or manual switching point

Manual switching point

Electro-hydraulic control with self-supply

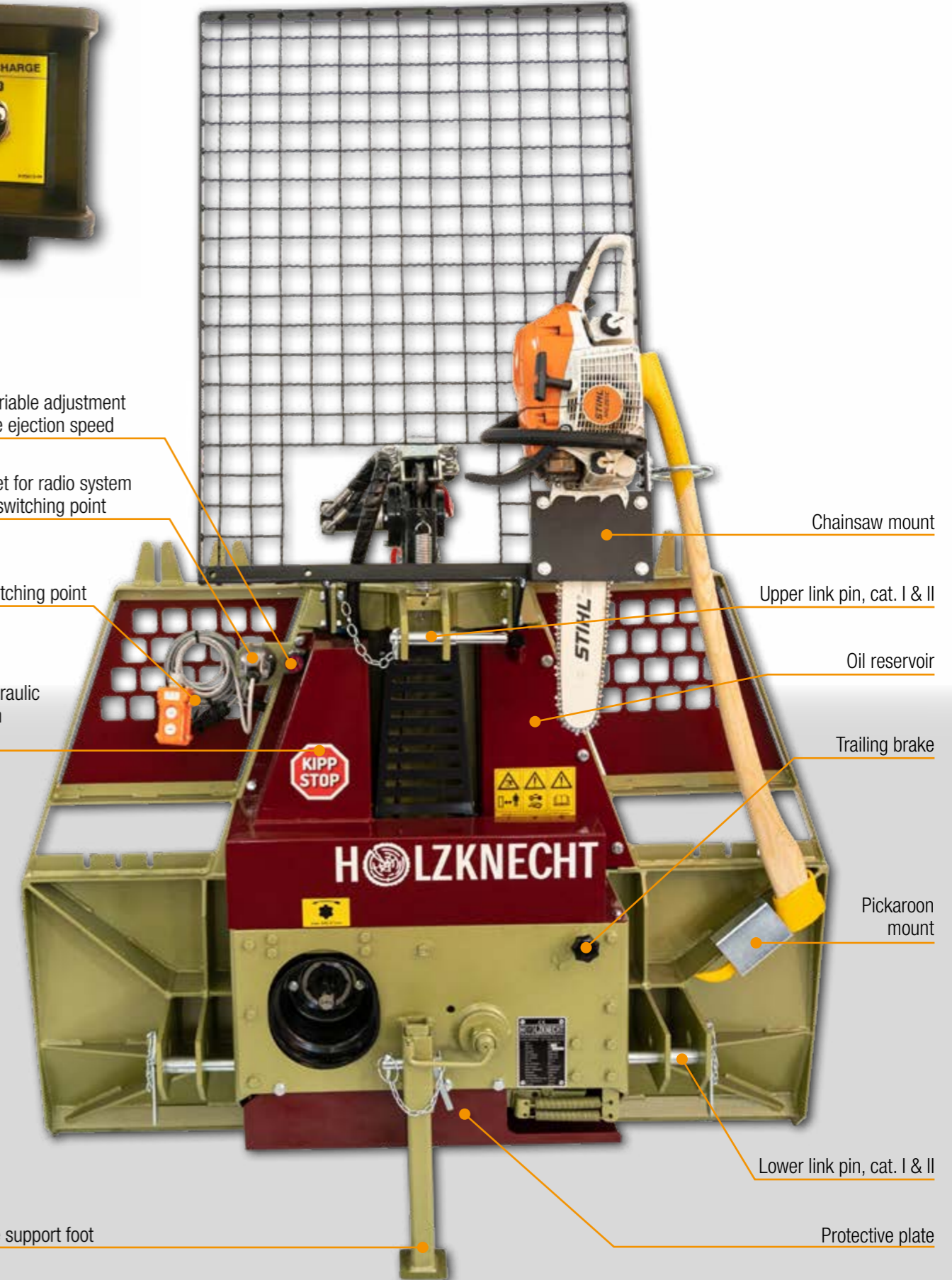

Sandgestrahlt & hochwertige Lackierung

HOLZKNECHT HS 5 CLASSIC



■ Hydraulic cable ejection



AS STANDARD,
DEACTIVATED VIA RADIO

TECHNICAL SPECIFICATIONS:

	HS 5 Classic
Tractive performance	5,0 t
Cable retraction speed	33m / min
Cable attachment	80m / 10 Ø 100m / 9 Ø
Recommended cable length	70m / 10 Ø
Blade width	1.500 mm
Cable winch height with protective grille	2.150 mm
Cable intake height	1.250 mm
Weight	290 kg
For tractors from	20 kW



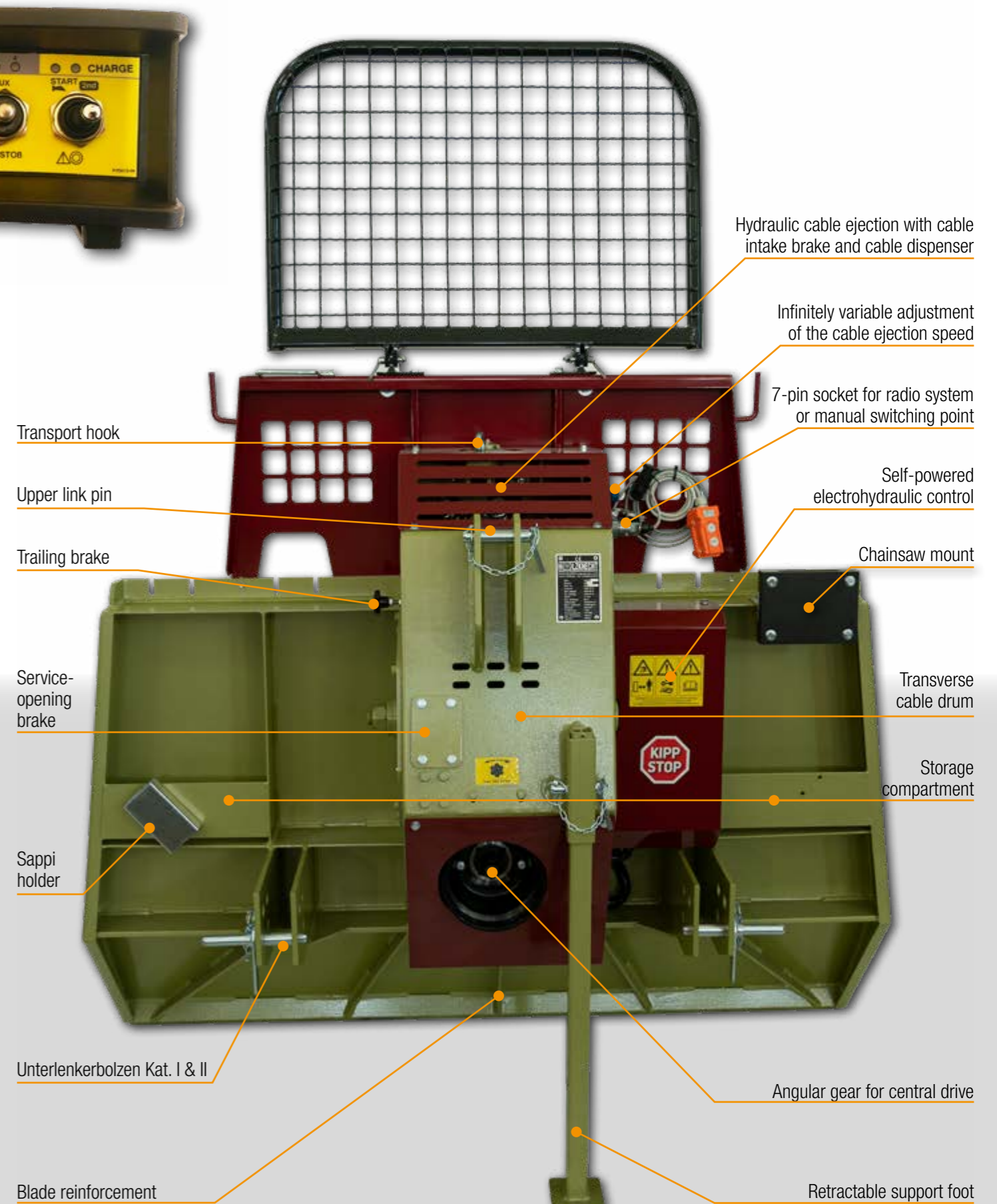
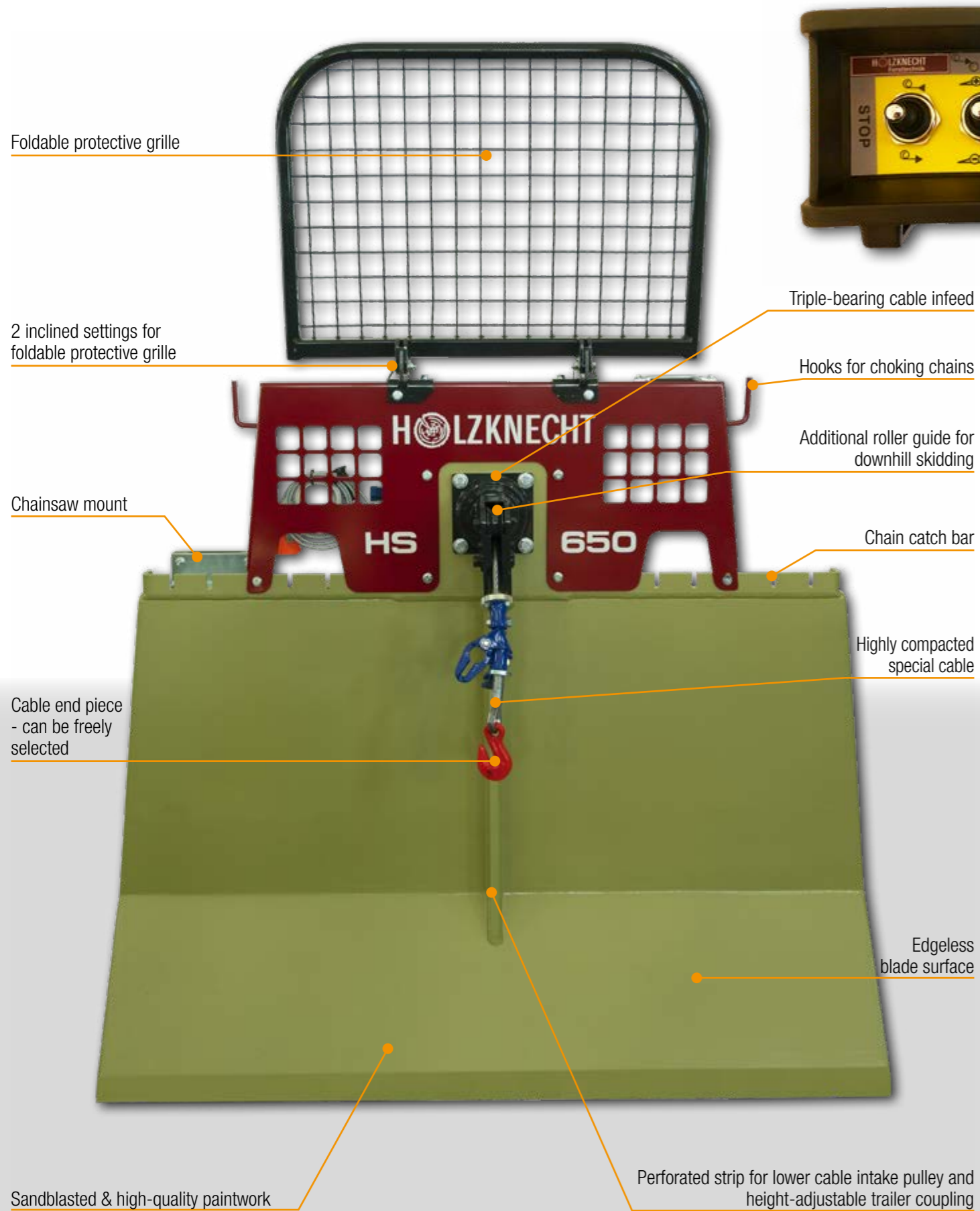

HOLZKNECHT HS 550 • HS 650 • HS 750 • HS 850



Hydraulic cable ejector with cable dispenser

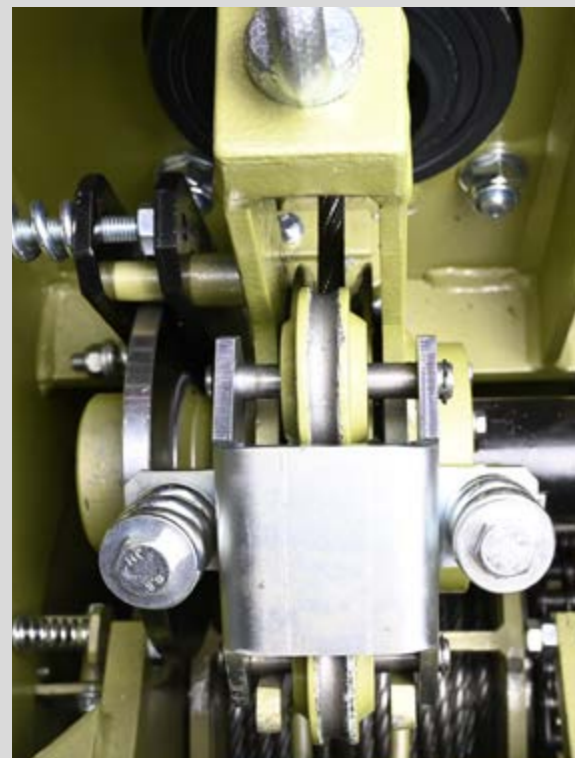

AS STANDARD,
DEACTIVATED VIA RADIO

TECHNICAL SPECIFICATIONS:

	HS 550	HS 650
Tractive performance	5,5 t	6,5 t
Cable retraction speed	26m / min	26m / min
Cable attachment	85m / 11 Ø	85m / 11 Ø
	100m / 10 Ø	100m / 10 Ø
Recommended cable length	80m / 10 Ø	80m / 11 Ø
Blade width	1.600 mm	1.750 mm
Cable winch height with protective grille	2.050 mm	2.350 mm
Cable intake height	1.150 mm	1.200 mm
Weight	370 kg	440 kg
For tractors from	20 kW	30 kW

Cable intake brake with cable dispenser



TECHNICAL SPECIFICATIONS:

	HS 750	HS 850
Tractive performance	7,5 t	8,5 t
Cable retraction speed	26m / min	26m / min
Cable attachment	85m / 13 Ø	85m / 13 Ø
	100m / 12 Ø	100m / 12 Ø
Recommended cable length	100m / 11 Ø	100m / 11 Ø
Blade width	1.900 mm	2.100 mm
Cable winch height with protective grille	2.300 mm	2.350 mm
Cable intake height	1.300 mm	1.350 mm
Weight	490 kg	540 kg
For tractors from	40 kW	50 kW

HOLZKNECHT HS 66 - 77

GEAR CHAIN TECHNOLOGY with proportional brake

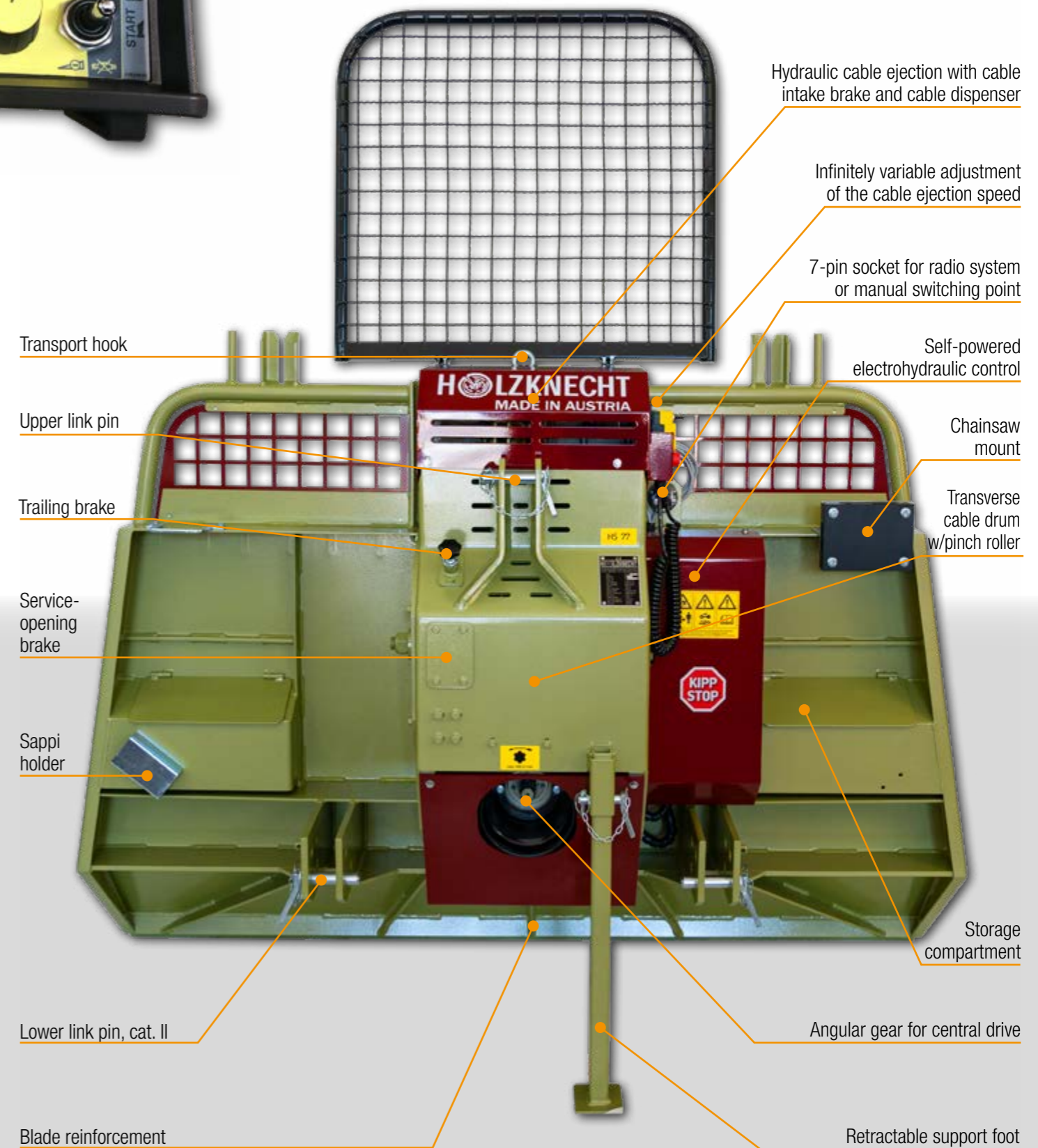
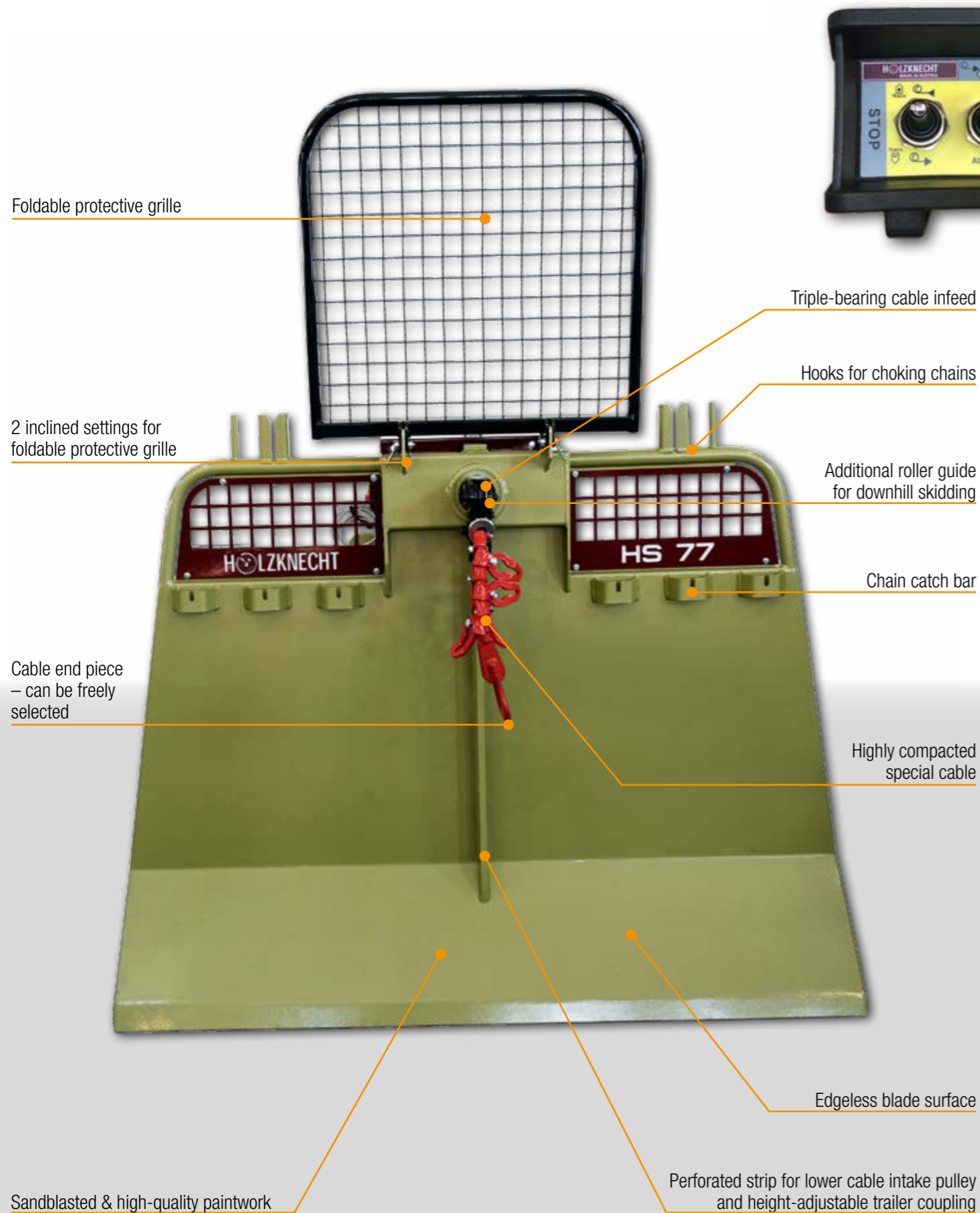

HOLZKNECHT HS 66 • HS 77 • HS 77K



■ Hydraulic folding blade, adjustable 90°

■ Cable intake brake with cable dispenser



AS STANDARD,
DEACTIVATED VIA RADIO

TECHNICAL SPECIFICATIONS:

	HS 66	HS 77
Tractive performance	6,6 Tonnen	7,7 Tonnen
Cable retraction speed	26m / min	26m / min
Cable attachment	100m / 11mm	100m / 12mm
	80m / 12mm	80m / 13mm
Recommended cable length	80m / 11mm	80m / 12mm
Blade width	1.750 / 1.900mm	1.900 / 2.100mm
Cable winch height with protective grille	2.050mm	2.050mm
Cable intake height	1.300mm	1.350mm
Weight	450kg	540kg
For tractors from	40kW	50kW

ALL CABLE WINCHES
WITH PROPORTIONAL BRAKES
AS STANDARD

TECHNICAL SPECIFICATIONS:

	HS 77 folding blade
Tractive performance	7,7 Tonnen
Cable retraction speed	26m / min
Cable attachment	100m / 12mm
	80m / 13mm
Recommended cable length	80m / 12mm
Blade width	2.100mm
Cable winch height with protective grille	2.050mm
Cable intake height	1.350mm
Weight	650kg
For tractors from	50kW

■ Hydraulic cable ejector
with cable dispenser



HOLZKNECHT HS 408

GEAR CABLE WINCH

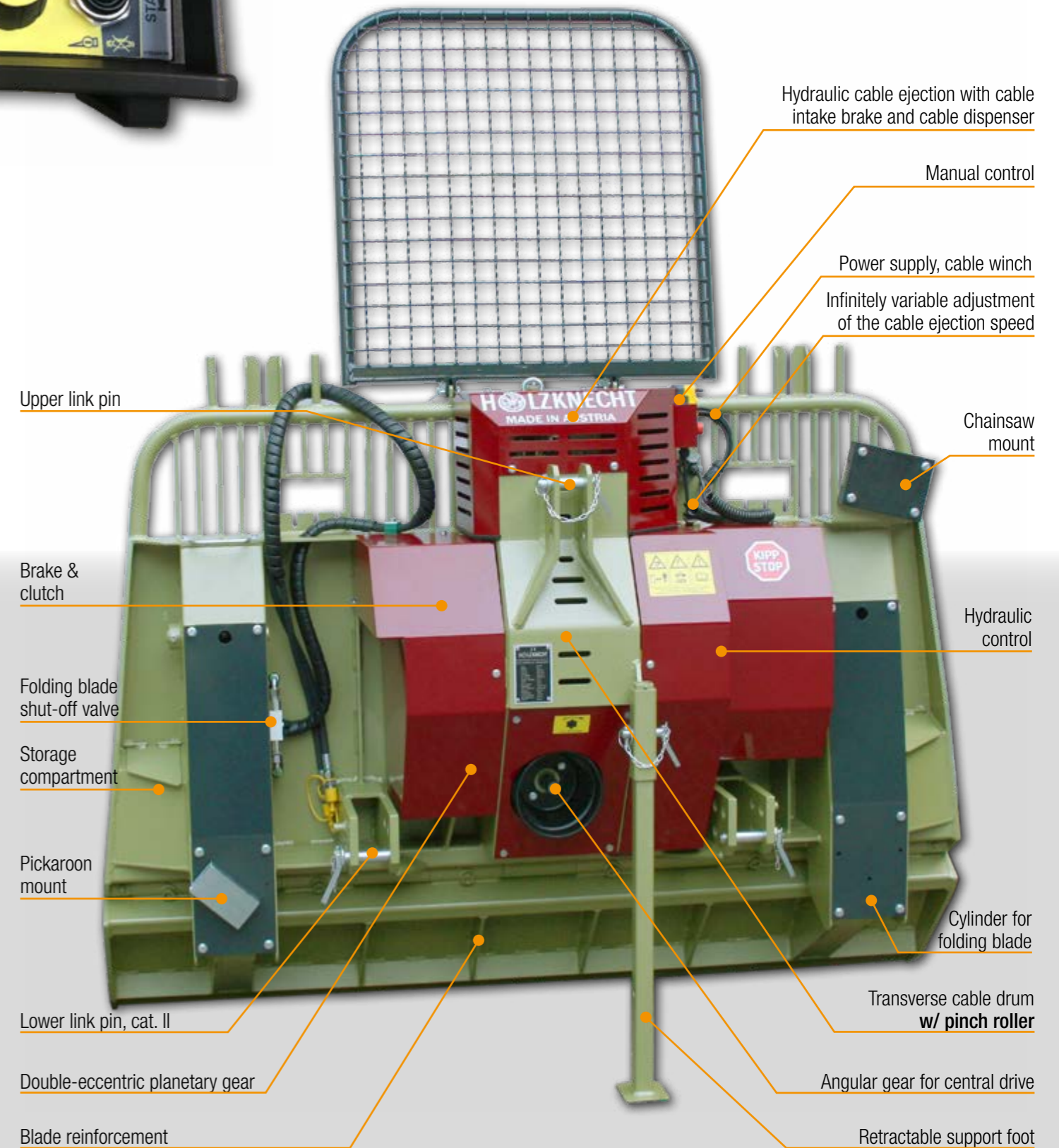
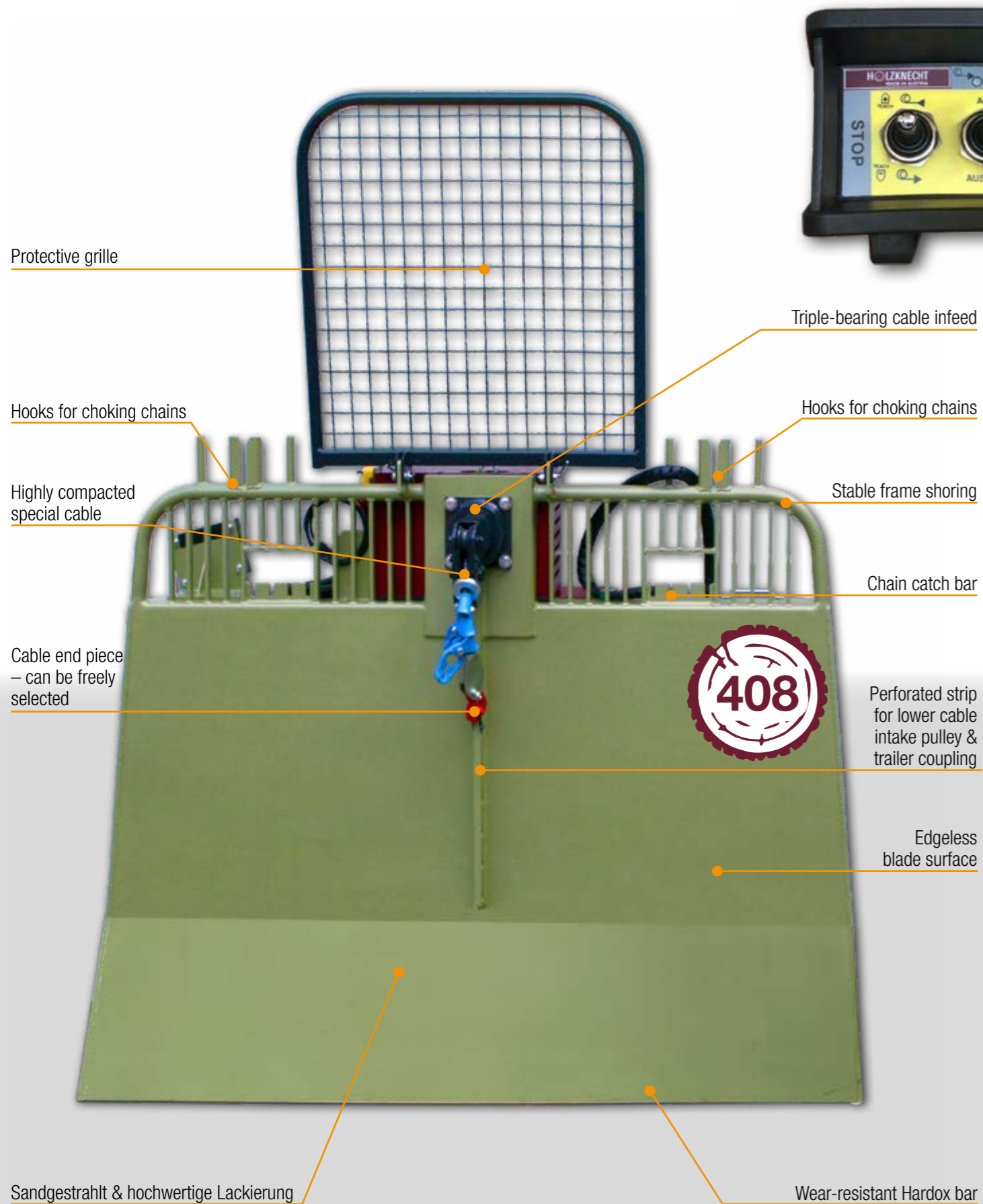

HOLZKNECHT HS 409

GEAR CABLE WINCH

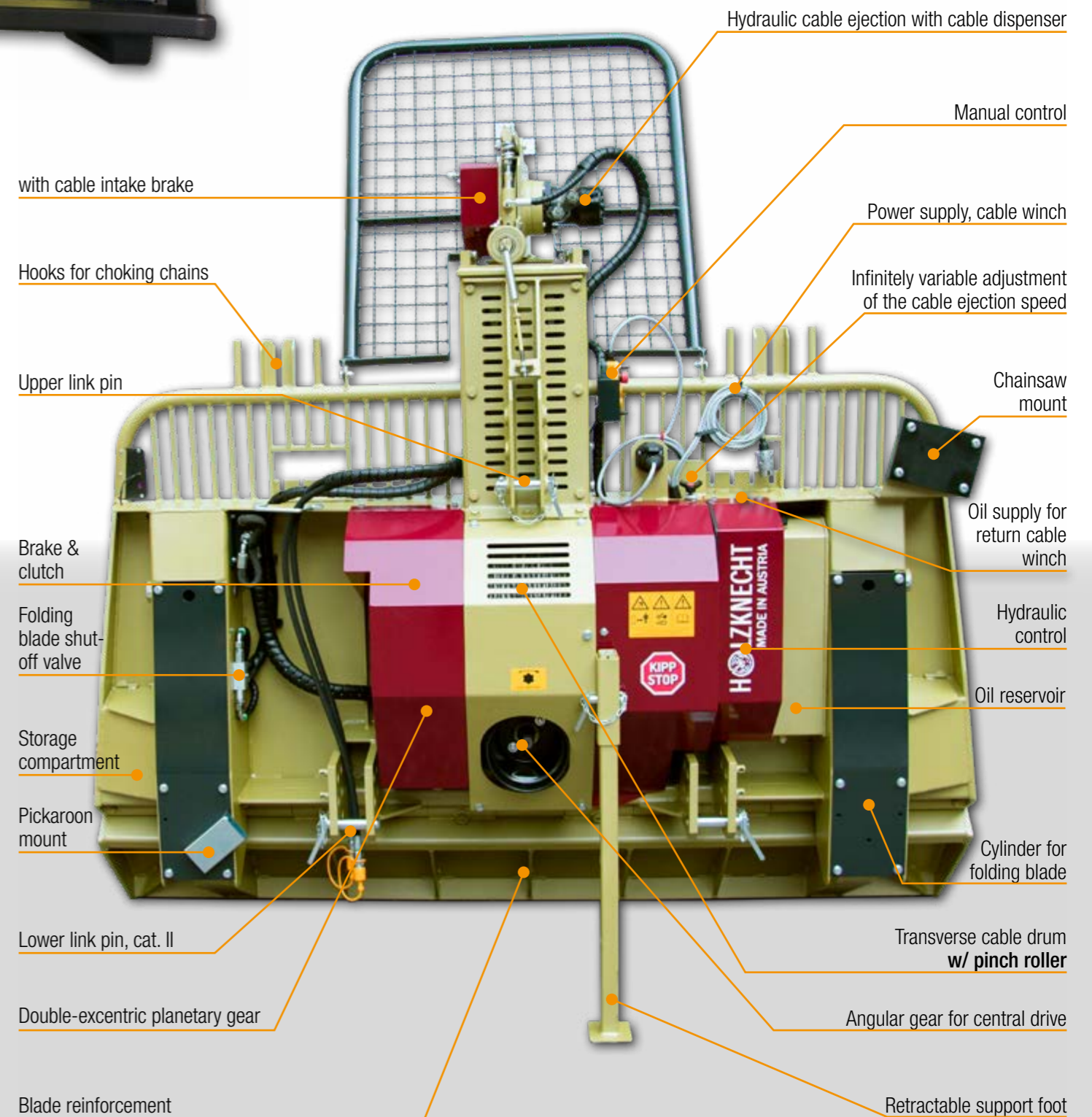
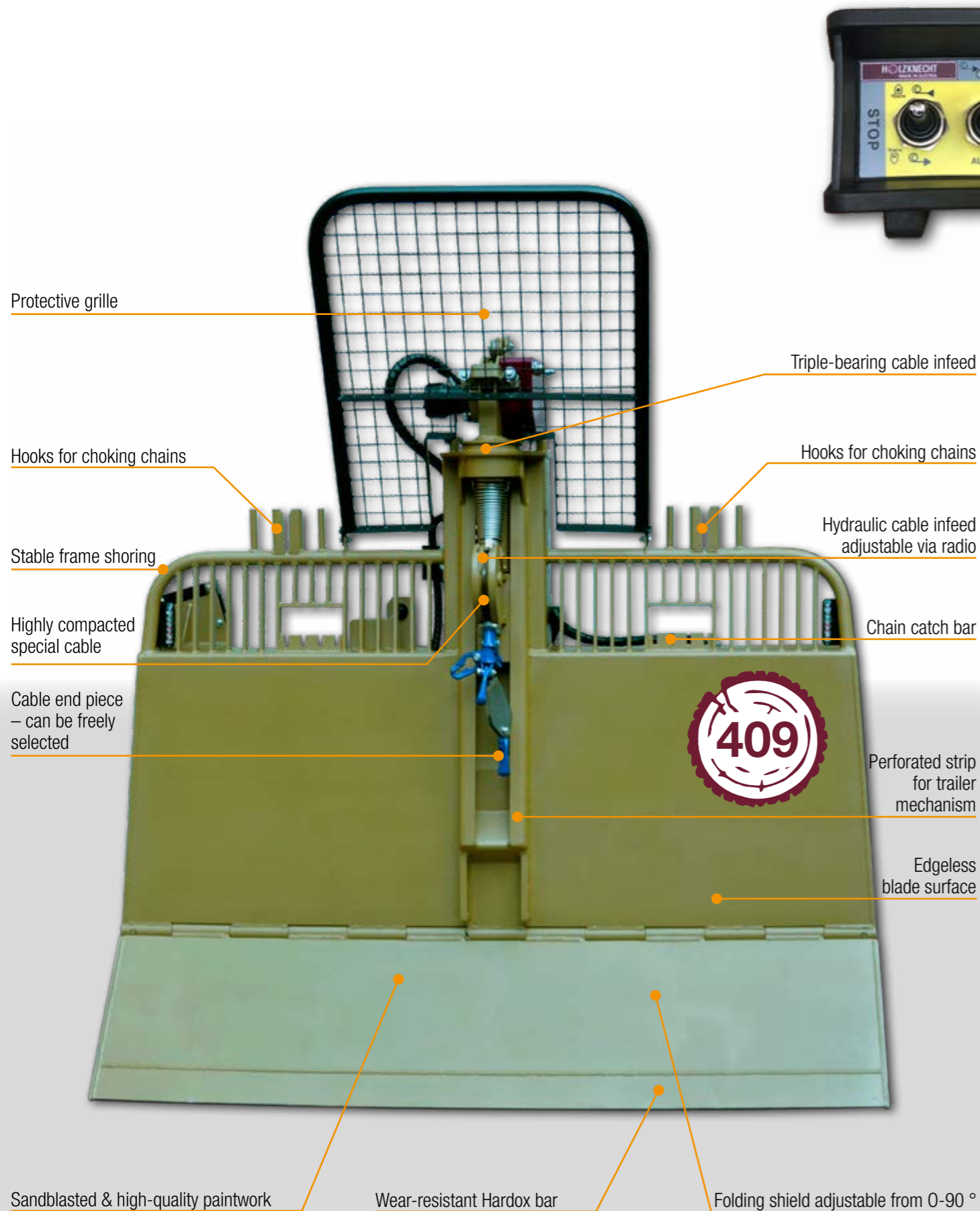



- Protective grille
- Hooks for choking chains
- Stable frame shoring
- Highly compacted special cable
- Cable end piece – can be freely selected
- Triple-bearing cable infeed
- Hooks for choking chains
- Hydraulic cable infeed adjustable via radio
- Chain catch bar
- Edgeless blade surface
- Perforated strip for trailer mechanism
- Sandblasted & high-quality paintwork
- Wear-resistant Hardox bar
- Folding shield adjustable from 0-90 °

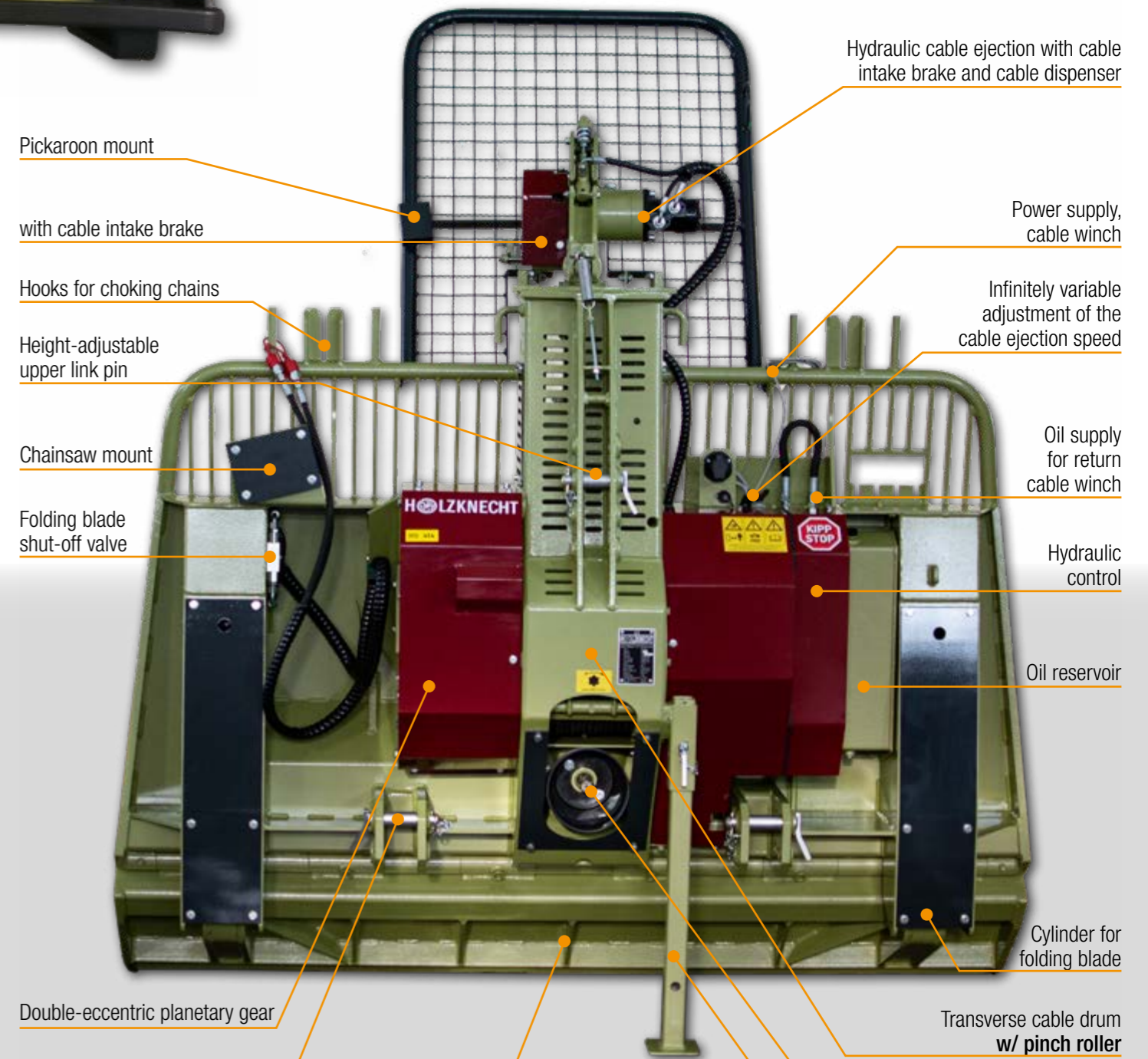

- Pickaroon mount with cable intake brake
- Hooks for choking chains
- Height-adjustable upper link pin
- Chainsaw mount
- Folding blade shut-off valve
- Double-eccentric planetary gear
- Lower link pin, cat. III
- Blade reinforcement
- Hydraulic cable ejection with cable intake brake and cable dispenser
- Power supply, cable winch
- Infinitely variable adjustment of the cable ejection speed
- Oil supply for return cable winch
- Hydraulic control
- Oil reservoir
- Cylinder for folding blade
- Transverse cable drum w/ pinch roller
- Angular gear for central drive
- Retractable support foot

HOLZKNECHT HS 408 • HS 409 • HS 411 • HS 414



■ Clutch & brake



AS STANDARD,
DEACTIVATED VIA RADIO

TECHNICAL SPECIFICATIONS:

	HS 408	HS 409
Tractive performance	8,0 t	9,0 t
Cable retraction speed	26m / min	26m / min
Cable attachment	120m / 12 Ø	120m / 12 Ø
	100m / 13 Ø	100m / 13 Ø
Recommended cable length	100m / 12 Ø	100m / 12 Ø
Blade width	2.000 / 2.200mm	2.100 / 2.200mm
Blade width, folding blade	2.100 mm	2.100mm
Cable winch height with protective grille	2.400mm	2.500mm
Cable intake height	1.400mm	800 - 1.400mm
Weight	690kg	980kg
For tractors from	55 kW	55 kW

ALL CABLE WINCHES
WITH PROPORTIONAL BRAKES
AS STANDARD

TECHNICAL SPECIFICATIONS:

	HS 411	HS 414
Tractive performance	11,0 t	14,0 t
Cable retraction speed	26m / min	26m / min
Cable attachment	135m / 12 Ø	130m / 13 Ø
	115m / 13 Ø	110m / 14 Ø
Recommended cable length	120m / 12 Ø	120m / 13 Ø
Blade width	2.200 / 2.400mm	2.300 / 2.400mm
Blade width, folding blade	as standard	as standard
Cable winch height with protective grille	2.500mm	2.700mm
Cable intake height	800 - 1.400mm	800 - 1.400mm
Weight	1.050kg	1.270kg
For tractors from	75 kW	90 kW

■ Electrohydraulic control



HOLZKNECHT RETURN CABLE WINCH RS 500



■ Detachable cable drum



■ Compact construction

- Low dead weight
- Tractive performance 500 kg
- Remote-controlled via radio
- Can be set up on the left and right
- Can also be set up on third-party products
- Detachable cable drum
- Large cable holder (300 m / 4.6 mm)
- Height-adjustable cable infeed
- Including deflection set & 300 m plastic rope



■ Deflection set

■ Trailing brake



■ Infinitely variable adjustment of the cable ejection speed



TECHNICAL SPECIFICATIONS:

	RS 500
Tractive performance	500 kg
Cable holder	300m / 4,6mm
Weight of the cable drum	9 kg
Total weight	55kg

HOLZKNECHT WOODENKNIGHT WOODPILE BLADE

RETARDERBREMSE BRAKE HRB I - IV

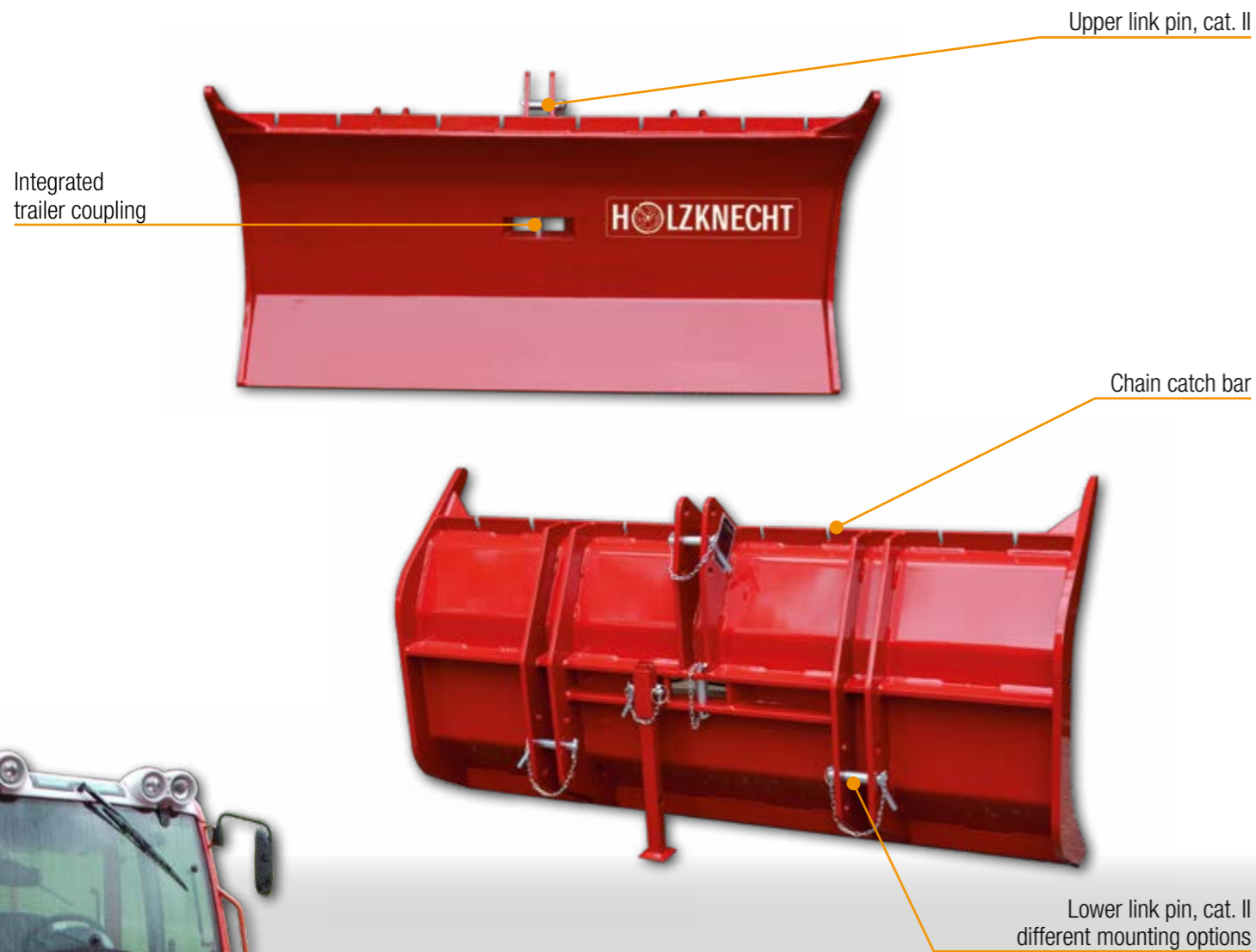

TECHNICAL SPECIFICATIONS:

	HPS 185
Blade width	1.850 mm
Coupling	KAT II
Weight	250kg

- 4 different sizes
- 4-stage brake selector switch
- Additional weights of up to 800 kg possible
- Different attachment variants possible



TECHNICAL SPECIFICATIONS:

	Max. braking force
HRB I up to 80 hp	approx. 400 Nm
HRB I up to 100 hp	approx. 550 Nm
HRB III over 100 hp	approx. 1.000 Nm
HRB IV over 200 hp	ca. 1.500 Nm



LOWER CABLE INTAKE PULLEYS / DEFLECTION PULLEYS



HS 135 - 155 • HS 5 Classic



HS 66-77 • HS 550-850 • HS 408



Deflection roller 5, 8 or 10 tons

UNIVERSAL JOINT SHAFTS / TREE PROTECTOR



Universal joint shaft size W 2200 - W 2400



Tree protector

LIFTING EQUIPMENT



Cable lock with parallel hook



Cable lock with parallel hook



Sliding cable clamps



Choking chains

COUPLING DEVICES



HS 135 - HS 77 • HS 408



HS HS 409 - HS 414

HOLZKNECHT „AUTC“ RADIO

Functions: pulling, releasing, short releasing switch for cable ejection prepared for gas + and - engine start and engine stop

Scope of delivery: Receiver including antenna transmitter with belt USB charging cable 230V & 12V charging plug



HOLZKNECHT „AUTC PROPORTIONAL“ RADIO

Functions: pulling, releasing, short releasing switch for cable ejection prepared for gas + and - engine start and engine stop

Scope of delivery: Receiver including antenna transmitter with belt USB charging cable 230V & 12V charging plug



HOLZKNECHT
MADE IN AUSTRIA

SCHNITZHOFER GES.M.B.H.
Leitenhaus 11
A - 5524 Annaberg
Tel.: +43 (0)6243 / 2678
Fax: +43 (0)6243 / 2678 - 12
E-Mail: office@holz knecht.at
www.holz knecht.at

